



Installation

SINCE 1978



LEADING LIGHT

VK/04716/60, VK/04716/80, VK/04716/100, VK/04716/120

Please read the instructions carefully before commencing assembly

PRODUCT FEATURES

1. Simple structure, compact size, and easy installation.
2. Silent operation, no glare, high CRI, and high light transmittance.
3. Energy-saving, eco-friendly design with a lifespan of up to 50,000 hours.
4. Suitable for a wide range of applications.

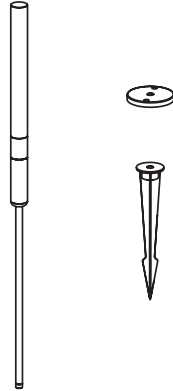

1

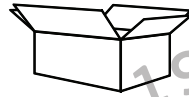

2

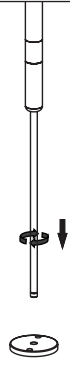

DC24V - 1W

3

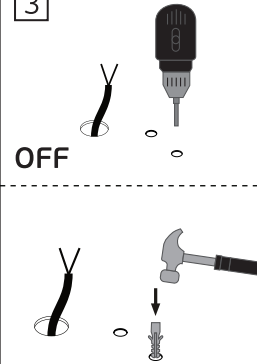

4

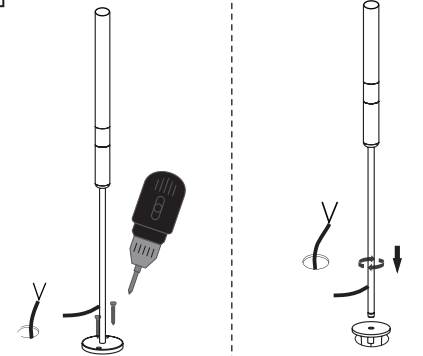

SAFETY NOTICE

Please read these installation instructions carefully before installing the product. Installation must be performed by a qualified professional. Failure to follow these instructions may result in damage, fire, or personal injury.

1. When using this product, ensure the correct voltage is applied.
2. Use locally approved identification cables. The cable rating must exceed the product's voltage and current requirements.
3. Turn off the power before wiring or performing any operation.
4. If parts need to be replaced or repaired, use only specified parts supplied by the manufacturer. Repairs must be carried out by the supplier or a qualified professional. Improper handling may result in electric shock or other hazards.
5. Do not use chemicals or abrasive materials when cleaning. Use a soft, damp cloth only.
6. Do not clean the product with high-pressure washers.
7. Do not disassemble, damage, or modify the product.
8. When the lamp is in operation, do not use it continuously for extended periods to avoid heat damage.

WARNING

This lamp and its power supply must not be installed on combustible surfaces or in areas containing explosive gases, flammable liquids, or dust.

5

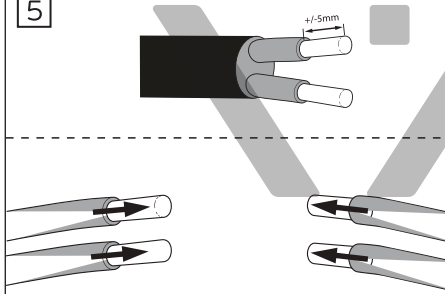

7

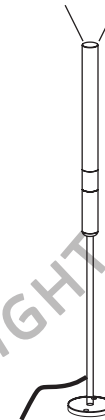

6

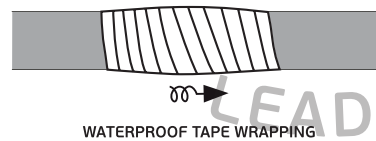

WATERPROOF TAPE WRAPPING

INSTALLATION SPIKE

VK Leading Light / Vaios I. Karakostas S.A. Imports - Exports Trade

A: 8 Aristotelous St, Tavros, 177 78 Athens, Greece T: +30 210 99 69 610-11, +30 210 34 58 072, +30 210 34 58 075

F: +30 210 99 58 374 E: info@vkleadinglight.gr W: vkleadinglight.gr



Spike installation

SINCE 1978



LEADING LIGHT

VK/04716/60, VK/04716/80, VK/04716/100, VK/04716/120

Please read the instructions carefully before commencing assembly

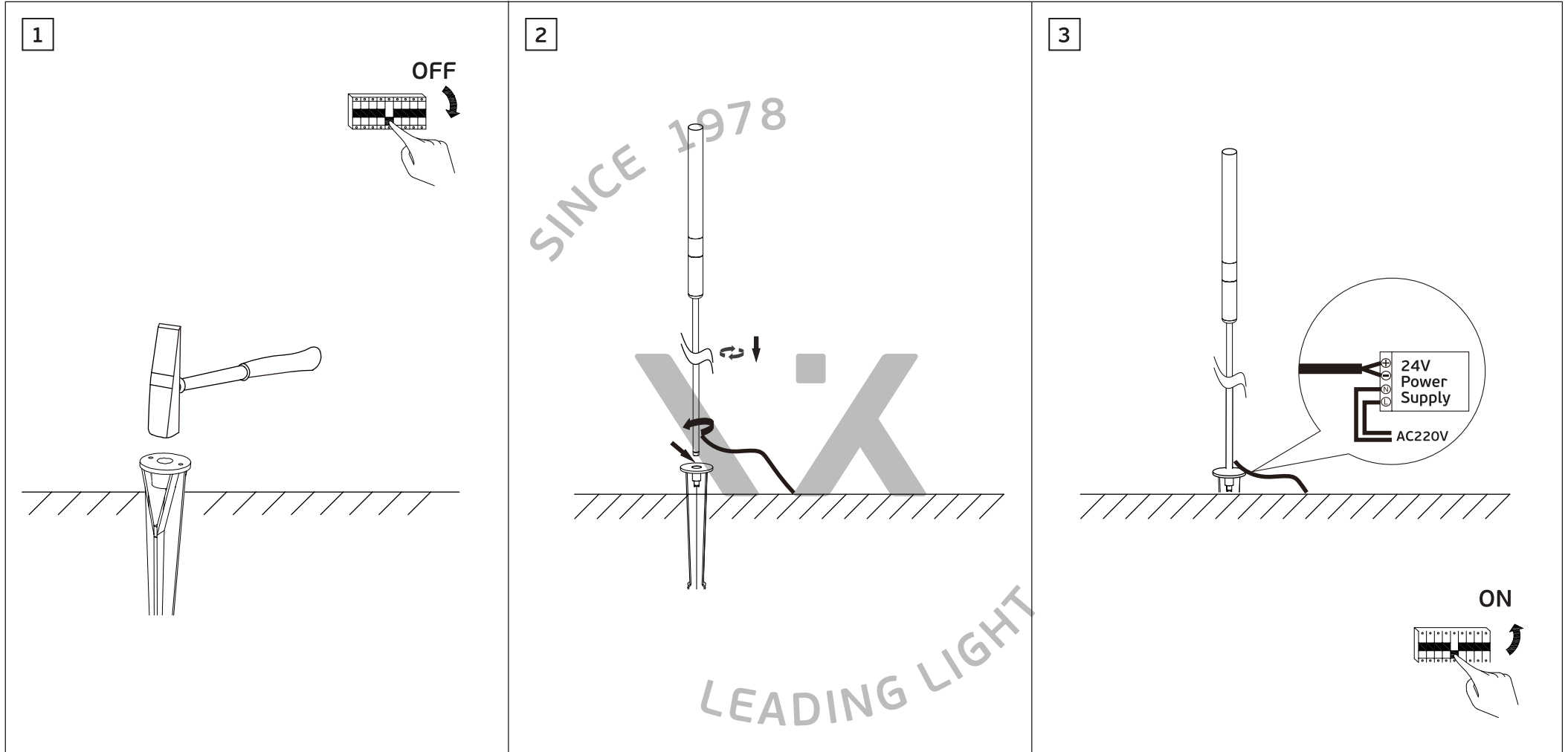

VK Leading Light / Vaios I. Karakostas S.A. Imports - Exports Trade

A: 8 Aristotelous St, Tavros, 177 78 Athens, Greece T: +30 210 99 69 610-11, +30 210 34 58 072, +30 210 34 58 075
F: +30 210 99 58 374 E: info@vkleadinglight.gr W: vkleadinglight.gr